



WATERPROOFING

ALSAN TRAFIK[®] HP 500 LIQUID WATERPROOFING

PARKINGS DECKS

POLYURETHANE COATING SYSTEM FOR VEHICULAR OR PEDESTRIAN
TRAFFIC AREAS

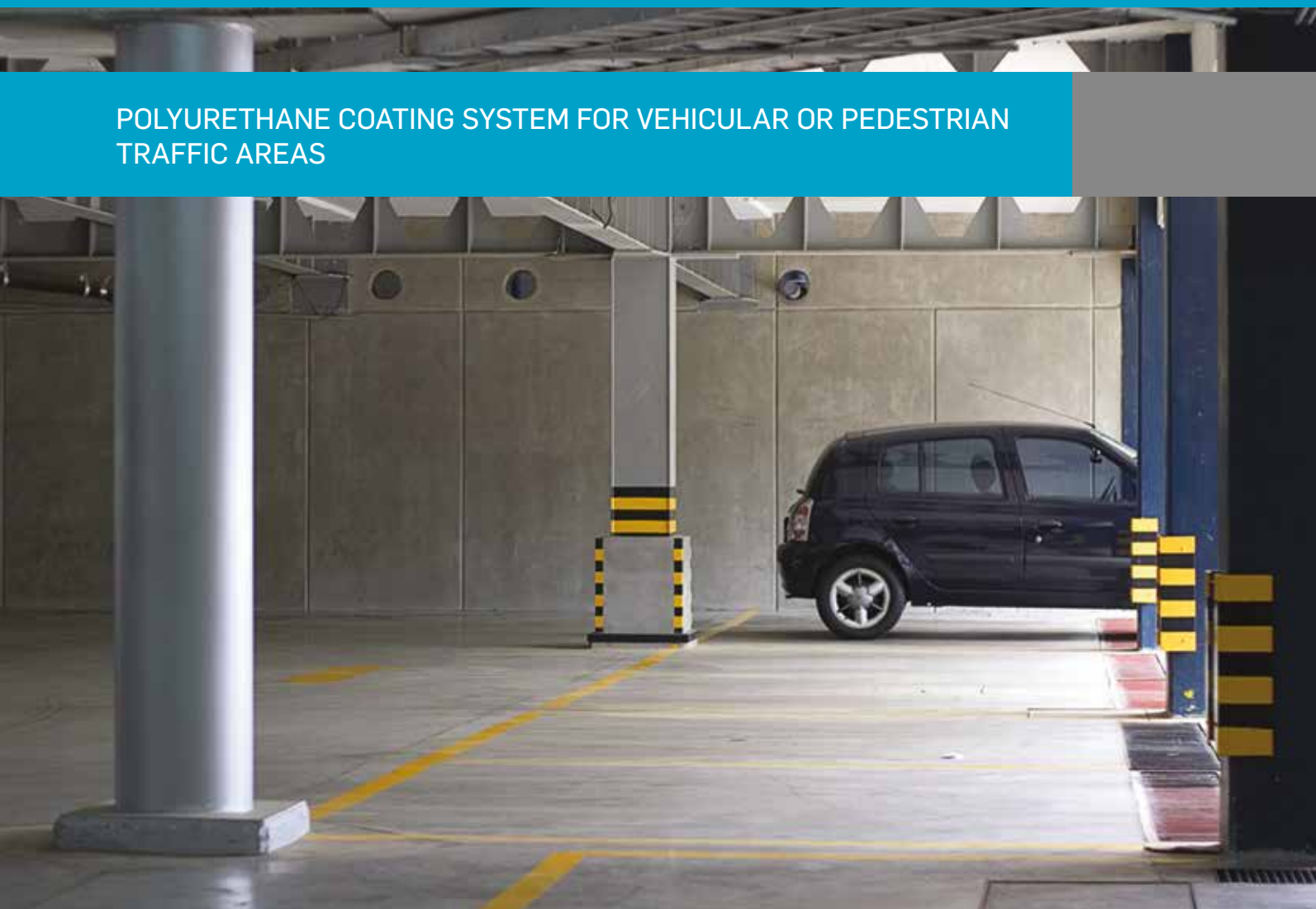

SOPREMA[®]



ALSAN TRAFIK[®] HP 500

ALSAN TRAFIK HP 500 is a highly resistant liquid waterproofing system. Part of SOPREMA's ALSAN line of polyurethane waterproofing products, ALSAN TRAFIK HP 500 system consists of a primer coat and three single-component polyurethane coats. Due to its superior elongation properties and high abrasive resistance, ALSAN TRAFIK HP 500 system waterproofs and protects concrete structures exposed to both pedestrian and vehicular traffic.

BENEFITS

■ Highly resistant

ALSAN TRAFIK HP 500 system resists puncture, wear, temperature variations and UV rays by providing optimal protection, even in high traffic areas.

■ Lightweight, heavy-duty system

ALSAN TRAFIK HP 500, weighing only 2kg/m², is a lightweight, heavy-duty system that does not need to be covered with concrete or asphalt, offering the maximum height in parking structures.

■ Eliminates risk of water infiltration

ALSAN TRAFIK HP 500 system is the perfect solution for waterproofing upstands and complex details. This liquid waterproofing technology provides a smooth, seamless membrane that reduces the risk of any infiltration.

■ Worry-free application

ALSAN TRAFIK HP 500 systems are single-component, polyurethane waterproofing products that require no on-site mixing, facilitating installation and reducing the risk of curing issues.

AT YOUR SERVICE, FROM DESIGN TO COMPLETION

A construction project can raise its own concerns and bring its specific contingencies. At SOPREMA, our technicians and technical representatives will accompany you through all stages of your project, wherever you are in the country. Thus each year, hundreds of building professionals choose SOPREMA, not only for the exceptional quality of its products, but also for the expertise and availability of its technical team with comprehensive and considerate service.

SERVICE

SUCCESS STORY

Alexandra Headlands Water Tower, QLD, Australia

Property type: Industrial

Project type: Remedial

Builder: Unity Water

Applicator: Simon Groth Accurate Waterproofing

Category: Concrete repair

The client had an old degraded membrane on the water tank that had failed. ALSAN TRAFIK HP 500 was put forward and approved by the client. The existing membrane was removed by mechanical means back to clean concrete. Cracks in the concrete were cleaned out and filled with a flexible quick-curing polyurethane sealant. ALSAN TRAFIK HP 500 was then installed using a five-coat application. The result was a seamless, UV-stable, flexible, tough waterproof membrane system that the client was very pleased with.



BEFORE



AFTER



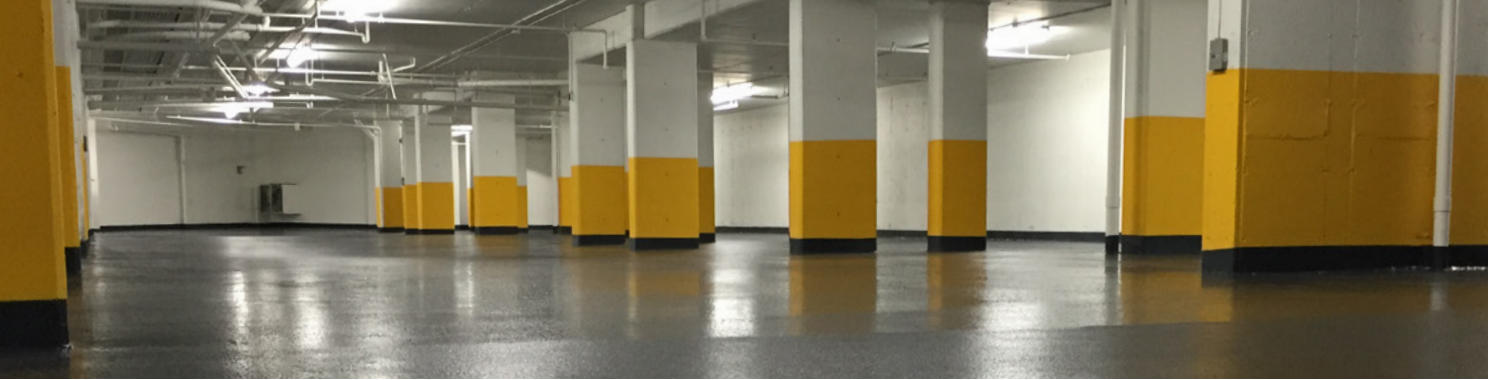



COMPONENTS



PRIMER
ALSAN TRAFIK HP 515
VOC-free, 100% solids, two-component primer used to maximize the adhesion of ALSAN TRAFIK HP 500 system.



WATERPROOFING LAYER
ALSAN TRAFIK HP 520
Single-component, ready-to-use, polyurethane waterproofing coating.



WEARING COURSE
ALSAN TRAFIK HP 530
Single-component, ready-to-use, polyurethane wearing course to ensure the durability of ALSAN TRAFIK HP 500 system.



FINISHING COAT
ALSAN TRAFIK HP 540
Single-component, ready-to-use, polyurethane finishing coat to ensure greater durability and easy cleaning.

SOPREMA's ALSAN line of polyurethane waterproofing products also includes a VOC-free and low-odor high-performance system, ALSAN TRAFIK HP 500 ZERO. Contact your local sales representative for more information.

BESPOKE SYSTEMS

PEDESTRIAN TRAFFIC & EXPOSED ROOF

For pedestrian traffic areas such as mechanical rooms, balconies, and plaza decks, a lighter solution can be used.

ALSAN TRAFIK HP 530 and aggregates

ALSAN TRAFIK HP 520

ALSAN TRAFIK HP 515



LIGHT-DUTY VEHICULAR TRAFFIC

For light-duty vehicular traffic areas such as multi-level parking garages, it is recommended to use an intermediary system to waterproof pedestrian walkways and parking stalls.

ALSAN TRAFIK HP 530 and aggregates

ALSAN TRAFIK HP 520

ALSAN TRAFIK HP 515

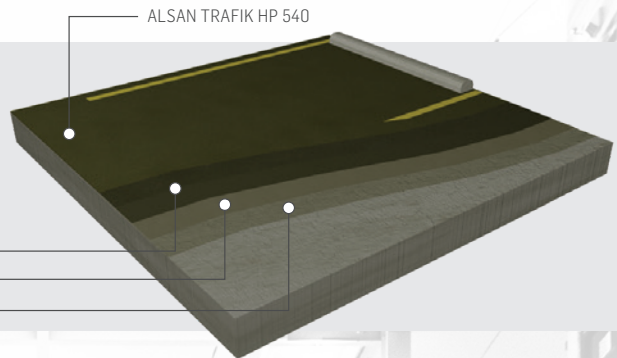

HEAVY-DUTY VEHICULAR TRAFFIC

For heavy-duty vehicular traffic areas, such as a turning radius, ramps and toll booths in multi-level parking garages, it is recommended to use the heavy-duty system.

Two coats of ALSAN TRAFIK HP 530 and aggregates

ALSAN TRAFIK HP 520

ALSAN TRAFIK HP 515

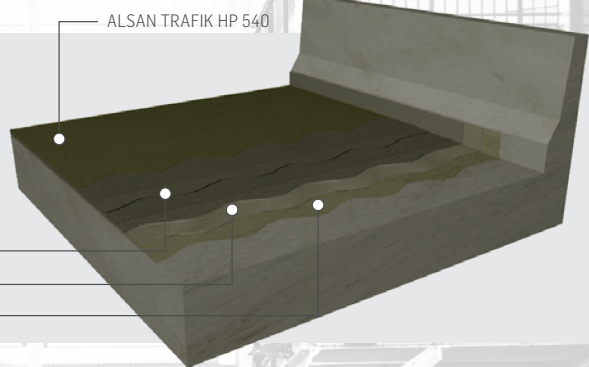

INNOVATION SINCE 1908

SOPREMA has developed around the idea that the quality, durability and reliability of materials must match builders' ambitions and expectations. For more than 100 years, SOPREMA has been using its expertise to develop a variety of high-end products that meet or exceed all the requirements of the construction field.



SOPREMA is an international manufacturer specializing in the production of waterproofing and insulation products, as well as vegetative and soundproofing solutions, for the building and civil engineering sectors.

SOPREMA ASIA PACIFIC

SINGAPORE

+65 6818 6353

Level 39, Marina Bay
Financial Centre,
Tower 2, 10 Marina
Boulevard,
Singapore, 018983

info@soprema.com.sg

HONG KONG

+852 3552 2848

Level 12, 1 Peking Road
Tsim Sha Tsui,
Kowloon, Hong Kong,
SAR,
China

info@soprema.hk

CHINA

+86 21 6252 1882

Unit E, Level 9, Block 4,
269 Tongxie Road
Shanghai,
China, 200335

info@soprema.cn

AUSTRALIA

+61 8046 7464

L 35,
100 Barangaroo Avenue,
Sydney, NSW
Australia, 2000

info@soprema.com.au